



SiBar Thyristor Surge Protectors

SiBar thyristor surge protection devices help protect sensitive telecom and datacom equipment from overvoltage events, including lightning transients, and operate as shunt devices in response to a surge that exceeds the breakover voltage. When the voltage exceeds the breakover voltage the SiBar device “folds back”, creating a low-impedance path, effectively shorting out the overvoltage condition.

Compliant with major standards such as GR-1089 Core, ITU-T-K20/K21, IEC61000-4-5 and FCC part 68, and UL1950, SiBar devices provide fast, bidirectional protection on communications network equipment, including analog and digital linecards, xDSL and ISDN modems, set-top boxes, T1 equipment, Voice over IP (VoIP) and Power over Ethernet (PoE) equipment.

The SiBar thyristor’s low on-state voltage allows for smaller form factor devices - as compared with clamping devices of comparable energy handling capability, and their relatively low capacitance makes them suitable for high data rate circuits.

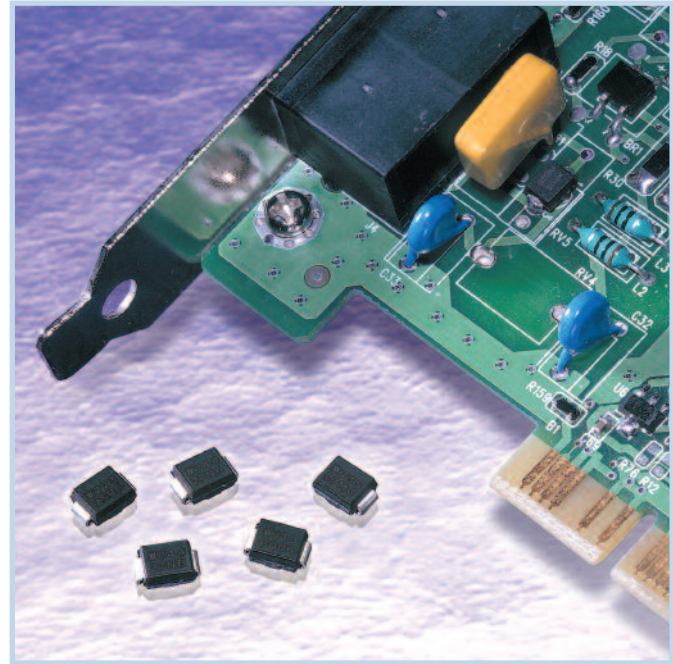

Benefits

- Helps provide protection for sensitive telecom electronic equipment
- Low leakage current
- Low power dissipation
- Lower capacitance for high speed telecom applications
- Fast, reliable operation
- No wear-out mechanisms
- Helps designers meet worldwide telecom standards
- Helps reduce warranty and service costs
- Easy installation
- Helps improve power efficiency of equipment

Features

- RoHS compliant available on all parts
- Bidirectional crowbar transient voltage protection
- High off-state impedance
- Low on-state voltage
- High surge capability
- New reduced and micro capacitance devices
- New expanded voltage offerings (6V-400V)
- Short-circuit failure mode
- Surface-mount technology

Applications

- Modems
- Fax machines
- Phones
- PBX systems
- POS systems
- Analog and digital linecards (xDSL, T1/E1...)
- Other customer premise and central office network equipment requiring protection

Protection Application Guide for SiBar Thyristor Surge Protectors

To use this guide, follow the steps below:

1. Select your equipment type from the guide below.
2. Select the type of protection depending on the agency and regional specifications in the second column.

Application	Region/ Specification	SiBar Thyristor Surge Protectors*	Overcurrent Protection		
			Form Factor Radial-leaded	Surface-mount	Chip
Customer premises equipment, IT equipment Analog modems, V.90 modems, ISDN modems, xDSL modems, ADSL splitters, phone sets, multifunction printers, fax machines, answering machines, caller ID, internet appliances, PBX systems, POS terminals, wall plugs	North America TIA-968-A (FCC Part 68), UL60950	TVBxxx(N/R)SA-L, TVBxxx(N/M)SB-L, or TVAxxx(N/R)SA-L	TRF600-150	TS600-170F TS600-200F	
	Europe/Asia/ South America ITU K.21	TVBxxx(N/R)SA-L TVAxxx(N/R)SA-L	TRF250-120 TRF250-145 TRF250-120T TRF250-180 TRF250-183	TS250-130F TSV250-130F	
Access network equipment (†) Remote terminals, line repeaters, multiplexers, cross-connects, WAN equipment	North America Telcordia GR-1089	TVBxxx(N/M/R)SC-L	TRF600-160	TS600-170F TS600-200F TSM600-250F TSM600-400F FT600-1250‡	
	Europe/Asia/ South America ITU K.45	TVBxxx(N/R)SA-L TVAxxx(N/R)SA-L	TRF250-120 TRF250-145 TRF250-120T TRF250-180 TRF250-183	TS250-130F TSV250-130F	
Central office switching equipment (†) Analog/POTS linecards, ISDN linecards, xDSL modems, ADSL/VDSL splitters, T1/E1 linecards, multiplexers, CSU/DSU, servers	North America Telcordia GR-1089	TVBxxx(N/M/R)SC-L	TRF600-160	TSM600-250F TSM600-170F TSM600-200F TSM600-400F FT600-1250‡	
	Europe/Asia/ South America ITU K.20	TVBxxx(N/R)SA-L TVAxxx(N/R)SA-L	TRF250-120 TRF250-145 TRF250-120T TRF250-180 TRF250-183	TS250-130F TSV250-130F	TCF250-180
Primary protection modules (†) MDF modules, Network Interface Devices (NID)	North America Telcordia GR-974	N/A	TRF250-180		
	Europe/Asia/ South America ITU K.20	TVBxxx(N/M/R)Sx-L	TRF250-120T TRF250-145T TRF250-145	TS250-130F TSV250-130F	TCF250-120T TCF250-180
Short-haul/intrabuilding equipment (†) LAN equipment, VoIP cards, cable telephony NIU's, wireless local loop handsets	North America Telcordia GR-1089 intrabuilding	TVBxxx(N/R)SA-L TVAxxx(N/R)SA-L	TRF250-120 TRF250-145 TRF250-120T	TS250-130F TSL250-080F TSV250-130F	
	Europe/Asia/ South America ITU K.21	TVBxxx(N/R)SA-L TVAxxx(N/R)SA-L	TRF250-120 TRF250-145 TRF250-180 TRF250-183	TS250-130F TSV250-130F	
LAN intrabuilding power cross protection LAN equipment, VoIP cards, IP phones		TVBxxx(N/R)SA-L TVAxxx(N/R)SA-L		TSL250-080F	
IEEE 802.3 Power over LAN protection Powered ethernet switches and terminals, IP phones, wireless LAN base stations, microcellular base stations, VoIP cards		N/A		decaSMD050F/60-2	
Cable telephony powering systems Power passing taps		N/A	BBRF550 BBRF750		

Note : This list is not exhaustive. Tyco Electronics welcomes our customers' input for additional application ideas.

* For more information on Raychem Circuit Protection PolySwitch resettable devices, refer to the telecommunications and networking devices section on page 184.

† For improved line balance in these applications, resistance-matched parts are recommended.

‡ FT600-1250 are surface mount telecom fuse devices. FT600-0500 and FT600-2000 reference also available. See FT600 section on page 100.

Table SB1 Electrical Characteristics, Part Marking and Agency Approval for SiBar Thyristor Surge Protectors

Part Number	V _{DM} Max. (V)	V _{BO} Max. (V)	I _H Min. (mA)	V _T Max. (V)	C ₁ @50V Typ. (pF)	C ₂ @ 2V Typ. (pF)	Part Marking	UL Approval
SMA 50A Standard "SA" and "NSA" Devices								
TVA170SA-L	170	265	150	4.0	20	39	170A	X
TVA170NSA-L	170	220	150	4.0	20	39	17NA	X
TVA200SA-L	200	320	150	4.0	17	33	200A	X
TVA220NSA-L	220	300	150	4.0	17	33	22NA	X
TVA270SA-L	270	365	150	4.0	16	31	270A	X
TVA275NSA-L	275	350	150	4.0	16	31	27NA	X
SMA 50A Reduced Capacitance "RSA" Devices								
TVA065RSA-L	65	88	150	4.0	20	40	A065	X
TVA090RSA-L	90	130	150	4.0	20	40	A090	X
TVA120RSA-L	120	160	150	4.0	16	30	A120	X
TVA130RSA-L	130	173	150	4.0	14	30	A130	X
TVA170RSA-L	170	220	150	4.0	14	25	A170	X
TVA190RSA-L	190	260	150	4.0	14	25	A190	X
TVA220RSA-L	220	295	150	4.0	12	25	A220	X
TVA270RSA-L	275	350	150	4.0	12	25	A270	X
TVA300RSA-L	320	400	150	4.0	12	25	A300	X
SMB 50A Standard "SA" and "NSA" Devices								
TVB058SA-L	58	77	150	4.0	43	80	058A	X
TVB058NSA-L	58	77	150	4.0	44	84	58NA	X
TVB065NSA-L	65	88	150	4.0	41	79	65NA	X
TVB075NSA-L	75	98	150	4.0	34	65	75NA	X
TVB090NSA-L	90	130	150	4.0	31	58	90NA	X
TVB120NSA-L	120	160	150	4.0	24	46	12NA	X
TVB140NSA-L	140	180	150	4.0	23	44	14NA	X
TVB170SA-L	170	265	150	4.0	18	35	170A	X
TVB170NSA-L	170	220	150	4.0	20	39	17NA	X
TVB180SA-L	180	219	150	4.0	30 (MAX)	60 (MAX)	180A	X
TVB180NSA-L	180	240	150	4.0	19	37	18NA	X
TVB190NSA-L	190	260	150	4.0	19	36	19NA	X
TVB200SA-L	200	320	150	4.0	18	35	200A	X
TVB220NSA-L	220	300	150	4.0	17	33	22NA	X
TVB270SA-L	270	365	150	4.0	15	32	270A	X
TVB275NSA-L	275	350	150	4.0	15	31	27NA	X
TVB300SA-L	300	400	150	4.0	14	27	300A	X
TVB320NSA-L	320	400	150	4.0	14	27	32NA	X
SMB 50A Reduced Capacitance "RSA" Devices								
TVB065RSA-L	65	88	150	4.0	20	40	65RA	X
TVB090RSA-L	90	130	150	4.0	20	40	90RA	X
TVB120RSA-L	120	160	150	4.0	16	30	12RA	X
TVB130RSA-L	130	173	150	4.0	14	30	13RA	X
TVB170RSA-L	170	220	150	4.0	14	25	17RA	X
TVB190RSA-L	190	260	150	4.0	14	25	19RA	X
TVB220RSA-L	220	295	150	4.0	12	25	22RA	X
TVB270RSA-L	275	350	150	4.0	12	25	27RA	X
TVB300RSA-L	320	400	150	4.0	12	25	30RA	X
SMB 80A Standard "SB" and "NSB" Devices								
TVB006SB-L	6	20	50 (TYP)	4.0	–	50 (TYP)	B006	X
TVB058NSB-L	58	77	150	4.0	67	129	58NB	X
TVB065NSB-L	65	88	150	4.0	64	123	65NB	X
TVB075NSB-L	75	98	150	4.0	63	122	75NB	X
TVB090NSB-L	90	130	150	4.0	49	95	90NB	X
TVB120NSB-L	120	160	150	4.0	38	75	12NB	X
TVB140NSB-L	140	180	150	4.0	36	70	14NB	X
TVB170NSB-L	170	220	150	4.0	29	59	17NB	X
TVB180NSB-L	180	240	150	4.0	29	59	18NB	X
TVB190NSB-L	190	260	150	4.0	28	56	19NB	X
TVB200SB-L	200	320	150	4.0	30	49	200B	X
TVB220NSB-L	220	300	150	4.0	26	52	22NB	X

Table SB1 Electrical Characteristics, Part Marking and Agency Approval for SiBar Thyristor Surge Protectors

... Cont'd

Part Number	V _{DM} Max. (V)	V _{BO} Max. (V)	I _H Min. (mA)	V _T Max. (V)	C ₁ @50V Typ. (pF)	C ₂ @ 2V Typ. (pF)	Part Marking	UL Approval
SMB 80A Standard "SB" and "NSB" Devices								
TVB270SB-L	270	350	150	4.0	25	50	270B	X
TVB275NSB-L	275	350	150	4.0	23	47	27NB	X
TVB300SB-L	300	400	150	4.0	21	42	300B	X
TVB320NSB-L	320	400	150	4.0	22	44	32NB	X
SMB 80A Micro Capacitance "MSB" Devices								
TVB120MSB-L	120	160	150	4.0	12	25	12MB	X
TVB140MSB-L	140	180	150	4.0	12	25	14MB	X
TVB170MSB-L	170	220	150	4.0	12	25	17MB	X
TVB190MSB-L	190	260	150	4.0	12	25	19MB	X
TVB220MSB-L	220	295	150	4.0	12	25	22MB	X
TVB270MSB-L	275	350	150	4.0	12	25	27MB	X
TVB300MSB-L	320	400	150	4.0	12	25	30MB	X
SMB 100A Standard "SC" and "NSC" Devices								
TVB058NSC-L	58	77	150	4.0	114	222	58NC	X
TVB065NSC-L	65	88	150	4.0	103	198	65NC	X
TVB075NSC-L	75	98	150	4.0	90	176	75NC	X
TVB090NSC-L	90	130	150	4.0	79	154	90NC	X
TVB120NSC-L	120	160	150	4.0	72	140	12NC	X
TVB140NSC-L	140	180	150	4.0	66	130	14NC	X
TVB170SC-L	170	265	150	4.0	60	125	170C	X
TVB170NSC-L	170	220	150	4.0	48	99	17NC	X
TVB180NSC-L	180	240	150	4.0	48	97	18NC	X
TVB190NSC-L	190	260	150	4.0	44	90	19NC	X
TVB200SC-L	200	320	150	4.0	55	115	200C	X
TVB220NSC-L	220	300	150	4.0	41	81	22NC	X
TVB270SC-L	270	365	150	4.0	50	110	270C	X
TVB275NSC-L	275	350	150	4.0	38	76	27NC	X
TVB300SC-L	300	400	150	4.0	47	98	300C	X
TVB320NSC-L	320	400	150	4.0	35	71	32NC	X
SMB 100A Reduced Capacitance "RSC" Devices								
TVB006RSC-L	6	25	50 (typ)	4.0	—	75	06RC	X
TVB025RSC-L	25	40	150	4.0	—	65	25RC	X
TVB035RSC-L	35	55	150	4.0	—	55	35RC	X
TVB065RSC-L	65	88	150	4.0	45	90	65RC	X
TVB090RSC-L	90	125	150	4.0	40	80	90RC	X
TVB120RSC-L	120	160	150	4.0	35	75	12RC	X
TVB140RSC-L	140	180	150	4.0	30	65	14RC	X
TVB170RSC-L	170	220	150	4.0	30	60	17RC	X
TVB190RSC-L	190	260	150	4.0	30	60	19RC	X
TVB220RSC-L	220	295	150	4.0	30	60	22RC	X
TVB270RSC-L	275	350	150	4.0	30	60	27RC	X
TVB300RSC-L	320	400	150	4.0	25	50	30RC	X
TVB360RSC-L	360	460	150	4.0	25	50	36RC	X
TVB400RSC-L	400	540	150	4.0	20	45	40RC	X
SMB 100A Micro Capacitance "MSC" Devices								
TVB140MSC-L	140	180	150	4.0	30	60	14MC	X
TVB170MSC-L	170	220	150	4.0	25	50	17MC	X
TVB190MSC-L	190	260	150	4.0	25	45	19MC	X
TVB220MSC-L	220	295	150	4.0	20	40	22MC	X
TVB270MSC-L	275	350	150	4.0	20	40	27MC	X
TVB300MSC-L	320	400	150	4.0	20	40	30MC	X
TVB400MSC-L	400	530	150	4.0	15	30	40MC	X

Notes : All electrical characteristics are measured at 25°C.

 V_{DM} measured per UL497B pulse requirements: at max. off-state leakage current (IDM) = 5µA.

 V_{BO} measured at 100V/µs.

Table SB2 Surge Current Rating for SiBar Thyristor Surge Protectors

Part Number	TIA-968			Telcordia GR-1089*		IEC61000-4-5	ITU K.20/21/45*	I _{TSM} Min. (A)	di/dt (A/μs)	dV/dt (A/μs)
	Type A	Type B		I _{pp} (A) 10 x 1000μs	I _{pp} (A) 2 x 10μs	I _{pp} (A) 8 x 20μs	I _{pp} (A) 5 x 310μs (V _{OC} : 10x700μs)			
	I _{pp} (A) 5 x 320μs	I _{pp} (A) 10 x 560μs	I _{pp} (A) 10 x 160μs							
TVAx _{xx} SA-L	90	70	100	50	150	150	90	22	500	2000
TVAx _{xx} NSA-L	90	70	100	50	150	150	90	22	500	2000
TVAx _{xx} RSA-L	65	55	75	50	100	150	65	22	500	2000
TVB180SA-L	---	75	110	50	---	---	100	32	500	2000
TVB _{xx} SA-L	90	70	100	50	150	150	90	22	500	2000
TVB _{xx} NSA-L	90	70	100	50	150	150	90	22	500	2000
TVB _{xx} RSA-L	65	55	75	50	100	150	65	22	500	2000
TVB006SB-L	120	100	150	75	250	250	120	28	500	2000
TVB _{xx} SB-L	100	100	150	80	250	250	100	30	500	2000
TVB _{xx} NSB-L	100	100	150	80	250	250	100	30	500	2000
TVB _{xx} MSB-L	120	100	150	80	250	200	120	28	500	2000
TVB _{xx} SC-L	150	150	200	100	500	400	150	60	500	2000
TVB _{xx} NSC-L	150	150	200	100	500	400	200	60	500	2000
TVB _{xx} RSC-L	150	140	200	100	500	400	150	41	500	2000
TVB _{xx} MSC-L	150	140	200	100	500	300	150	41	500	2000

Notes : I_{TSM} : peak on-state surge current is measured at 60 Hz, one cycle.
 di/dt : critical rate-of-rise of on-state current (pulsed power amplifier Vmax = 600V; C = 30μF).
 dV/dt : critical rate-of-rise of off-stage voltage (linear wave form, V_O = rated V_{BO}, T_J = 25°C

* Lightning current wave forms for applicable industry specification.

Figure SB1 Voltage-Current Characteristics for SiBar Thyristor Surge Protectors

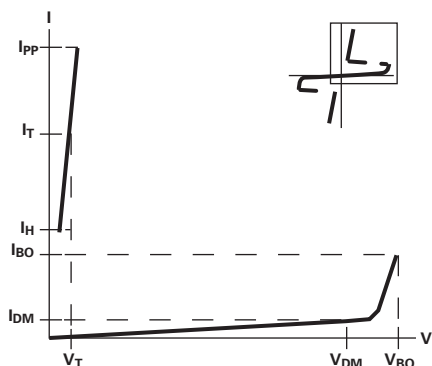

The voltage current (V-I) is useful in depicting the electrical characteristics of the SiBar thyristor surge protectors in relation to each other.

Table SB3 Parameter Definitions for SiBar Thyristor Surge Protectors

Symbol	Parameter	Definition
V _{BO}	Breakover voltage	Maximum voltage across the device at breakdown measured under a specified voltage and current rate of rise.
I _{BO}	Breakover current	Instantaneous current flowing at the breakover voltage (V _{BO}).
I _H	Hold current	Minimum current required to maintain the device in the on-state.
I _T	On-state current	Current through the device in the on-state condition.
V _T	On-state voltage	Voltage across the device in the on-state condition at a specified current (I _T).
V _{DM}	Maximum off-state voltage	Maximum DC voltage that can be applied to the device while maintaining it in the off-state condition.
I _{DM}	Off-state current	Maximum DC value of current that results from the application of the maximum off-state voltage.
I _{PP}	Peak pulse current	Rated peak pulse current of specified amplitude and waveshape that may be applied without damage.
di/dt, dV/dt	Critical rate of rise of on-state current and voltage	Maximum current and voltage rate of rise the device can withstand without damage.

Figure SB2-SB5 Typical Electrical Characteristics vs. Temperature for SiBar Thyristor Surge Protectors

Figure SB2

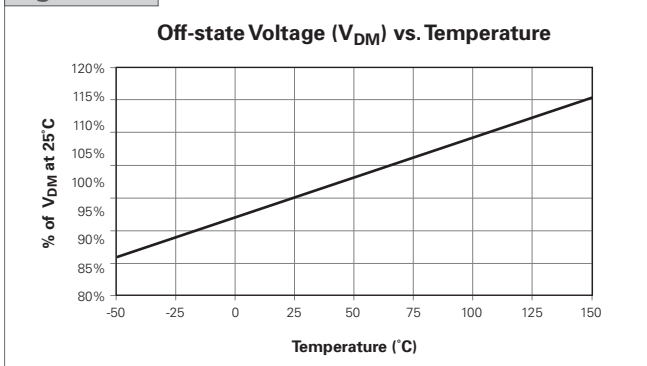

Figure SB3

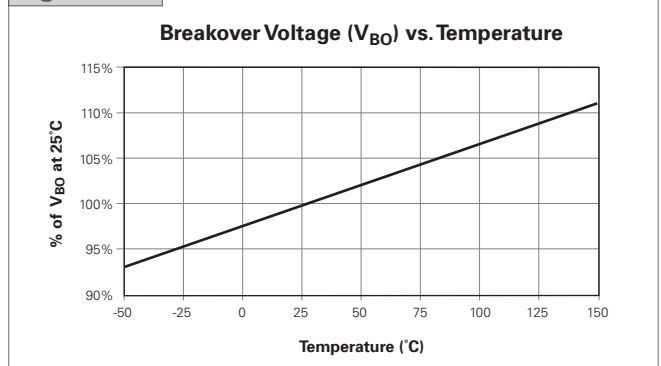

Figure SB4

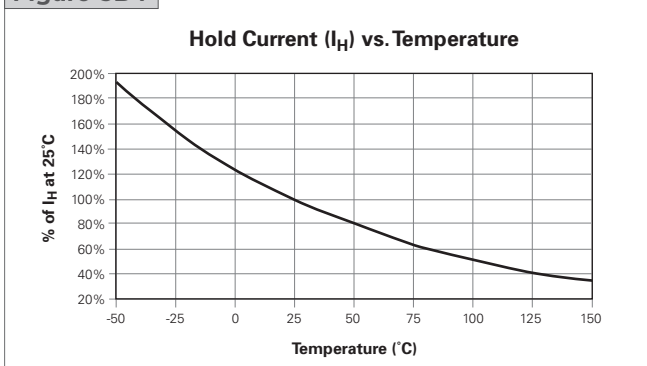

Figure SB5

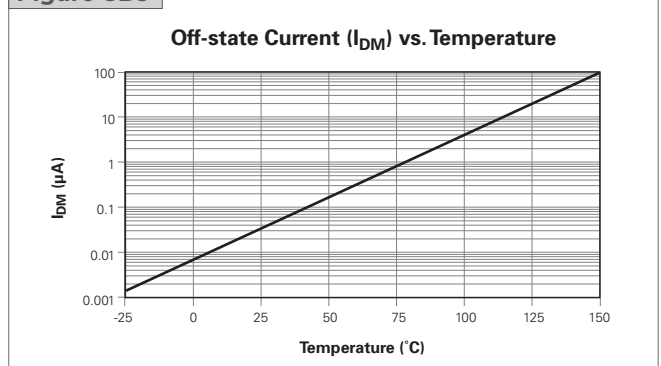

Table SB4 Dimensions for SiBar Thyristor Surge Protectors in Millimeters (Inches)

Dimension	A		B		C		D*		H		J		K		P	S	
	Min	Max	Min	Max	Min	Max	Min	Max	Min	Max	Min	Max	Min	Max	Ref.	Min	Max
▣ SMB Package:	4.06	4.57	3.30	3.94	1.90	2.41	1.95	2.20	0.051	0.200	0.150	0.31	0.76	1.27	0.51	5.21	5.59
▣ TVBxxx(M/N/R)Sx-L	(0.160)	(0.180)	(0.130)	(0.155)	(0.075)	(0.095)	(0.077)	(0.087)	(0.002)	(0.008)	(0.006)	(0.012)	(0.030)	(0.050)	(0.020)	(0.205)	(0.220)
▣ SMA Package:	4.06	4.57	2.25	2.92	1.90	2.41	1.25	1.65	0.051	0.200	0.150	0.41	0.76	1.52	0.51	4.80	5.59
▣ TVAxxx(N/R)Sx-L	(0.160)	(0.180)	(0.089)	(0.115)	(0.075)	(0.095)	(0.049)	(0.065)	(0.002)	(0.008)	(0.006)	(0.016)	(0.030)	(0.060)	(0.020)	(0.189)	(0.220)

Notes : TVA series devices use industry standard SMA package type. (JEDEC DO-214AC)
 TVB series devices use industry standard SMB package type. (JEDEC DO-214AA)
 All devices are bidirectional and may be oriented in either direction for installation.

* D dimension is measured within dimension P.

Figure SB6 Dimension Figure for SiBar Thyristor Surge Protectors

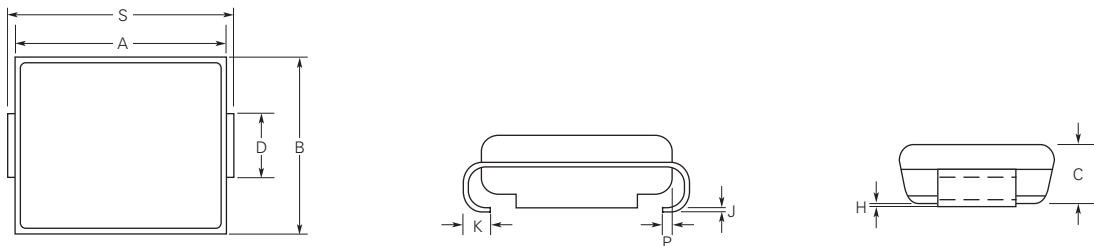

Table SB5 Physical Characteristics and Environmental Specifications for SiBar Thyristor Surge Protectors

Lead material	Matte tin finish (-L devices)
Encapsulating material	Epoxy, meets UL94V-0 requirements
Solderability	per MIL-STD-750, Method 2026
Solder heat withstand	per MIL-STD-750, Method 2031
Solvent resistance	per MIL-STD-750, Method 1022
Mechanical shock	per MIL-STD-750, Method 2016
Vibration	per MIL-STD-750, Method 2056
Storage temperature (°C)	-55°C to 150°C
Operating temperature (°C)	-40°C to 125°C
Junction temperature (°C)	175°C
Maximum lead temperature for soldering purpose; for 10s (°C)	260°C

Table SB6 Reliability Tests for SiBar Thyristor Surge Protectors

Test	Conditions	Duration
High temperature, reverse bias	+100°C, 50V _{DC} bias	1000 hours
High humidity, high temperature, reverse bias	85% RH, +85°C, 50V _{DC} bias	1000 hours
High temperature storage life	+150°C	1000 hours
Temperature cycling	-65°C to +150°C, 15 minute dwell	1000 cycles
Autoclave	100% RH, +121°C, 15 PSI	96 hours

Table SB7 Packaging Information for SiBar Thyristor Surge Protectors

Part Description	Tape and Reel Quantity	Standard Package	Recommended Pad Layout (millimeters/inches)		
			Dimension A (Nom.)	Dimension B (Nom.)	Dimension C (Nom.)
TVAxxxSA-L	5,000	20,000	2.000 (0.079)	2.000 (0.079)	2.000 (0.079)
TVAxxxNSA-L	5,000	20,000	2.000 (0.079)	2.000 (0.079)	2.000 (0.079)
TVAxxxRSA-L	5,000	20,000	2.000 (0.079)	2.000 (0.079)	2.000 (0.079)
TVBxxxSA-L	2,500	10,000	2.261 (0.089)	2.159 (0.085)	2.743 (0.108)
TVBxxxNSA-L	2,500	10,000	2.261 (0.089)	2.159 (0.085)	2.743 (0.108)
TVBxxxRSA-L	2,500	10,000	2.261 (0.089)	2.159 (0.085)	2.743 (0.108)
TVB006SB-L	2,500	10,000	2.261 (0.089)	2.159 (0.085)	2.743 (0.108)
TVBxxxSB-L	2,500	10,000	2.261 (0.089)	2.159 (0.085)	2.743 (0.108)
TVBxxxNSB-L	2,500	10,000	2.261 (0.089)	2.159 (0.085)	2.743 (0.108)
TVBxxxMSB-L	2,500	10,000	2.261 (0.089)	2.159 (0.085)	2.743 (0.108)
TVBxxxSC-L	2,500	10,000	2.261 (0.089)	2.159 (0.085)	2.743 (0.108)
TVBxxxNSC-L	2,500	10,000	2.261 (0.089)	2.159 (0.085)	2.743 (0.108)
TVBxxxMSC-L	2,500	10,000	2.261 (0.089)	2.159 (0.085)	2.743 (0.108)
TVBxxxRSC-L	2,500	10,000	2.261 (0.089)	2.159 (0.085)	2.743 (0.108)

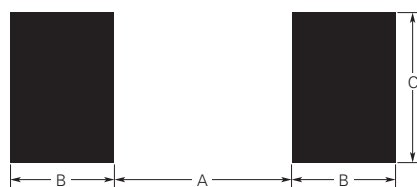
Figure SB7 Recommended Pad Layout for SiBar Thyristor Surge Protectors

Agency Recognition for SiBar Thyristor Surge Protectors

UL497B

File # E179610

Solder Reflow and Rework Recommendations for SiBar Thyristor Surge Protectors

SiBar thyristor devices are compatible with standard reflow and wave soldering techniques.

Solder Reflow

- Recommended reflow methods: IR, vapor phase oven, hot air oven.
- Always preheat the device to prevent excessive thermal shock and stress.
- Recommended maximum paste thickness of 0.25mm (0.010 in.).
- Devices may be cleaned using standard industry methods and solvents.

Solder Rework

- Use standard industry practices for the SiBar Thyristor Surge Protectors.

Figure SB8

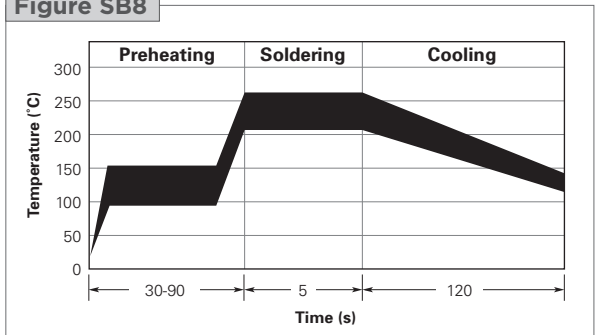

Table SB8 Tape and Reel Specifications for SiBar Thyristor Surge Protectors

SiBar thyristor devices are supplied on tape and reel per EIA481-1 standard. (See Figure SB9 and SB10 for details.)

Description	TVB Series		TVA Series	
	Dimensions (mm)	Tolerance (mm)	Dimensions (mm)	Tolerance (mm)
W	12	+/- 0.30	12	+/- 0.3
P ₀	4.0	+/- 0.10	4.0	+/- 0.10
P ₁	8.0	+/- 0.10	8.0	+/- 0.10
P ₂	2.0	+/- 0.10	2.0	+/- 0.10
A ₀	4.3	—	2.9	+/- 0.10
B ₀	6.2	—	5.59	+/- 0.10
B ₁ max.	8.2	—	8.2	—
D ₀	1.5	+ 0.1, -0.0	1.5	+ 0.1, -0
F	5.5	+/- 0.05	5.5	+/- 0.05
E ₁	1.75	+/- 0.10	1.75	+/- 0.10
E ₂ min.	9.85	—	9.85	—
T max.	0.6	—	0.6	—
T ₁ max.	0.1	—	0.1	—
K ₀ max.	2.59	+/- 0.10	2.36	+/- 0.10
Leader min.	390	—	390	—
Trailer min.	160	—	160	—

Figure SB9 EIA Referenced Taped Component Dimensions for SiBar Thyristor Surge Protectors

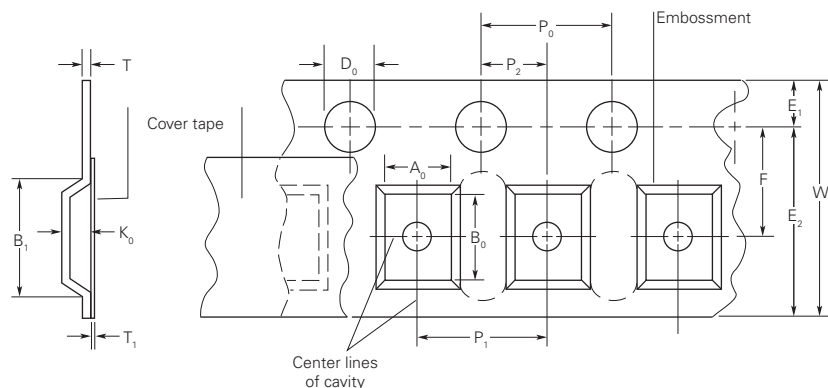
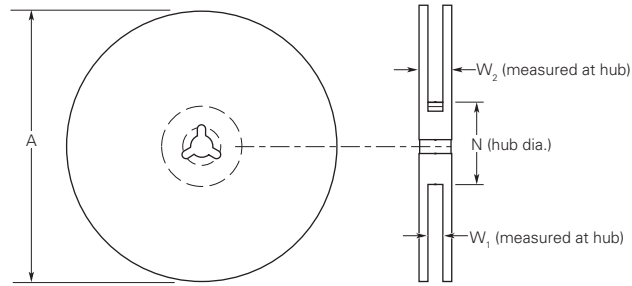

Figure SB10 EIA Referenced Reel Dimensions for SiBar Thyristor Surge Protectors

Reel Dimension

A max.	330
N min.	50
W_1	12.4 + 2.0, -0
W_2 max.	18.4



Part Numbering System for SiBar Thyristor Surge Protectors

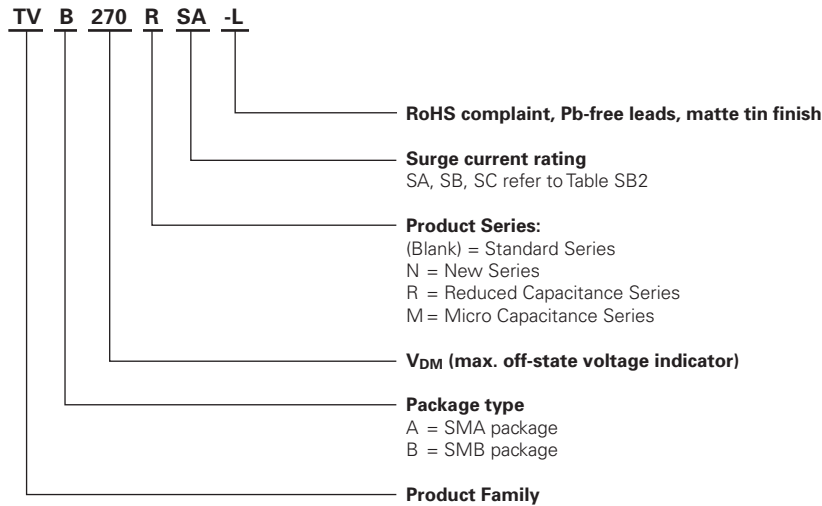

Warning :

- Operation beyond the maximum ratings or improper use may result in device damage and possible electrical arcing and flame.
- The devices are intended for protection against occasional overvoltage fault conditions and should not be used when repeated fault conditions or prolonged trip events are anticipated.
- Device performance can be impacted negatively if devices are handled in a manner inconsistent with recommended electronic, thermal, and mechanical procedures for electronic components.